

## INSTALLATION MANUAL FOR GLASS PROFILE PARTITIONS

DAN-doors A/S, Industrivej 19, 8660 Skanderborg, Danmark

### 1. PURPOSE

This installation manual deals with glass profile products (applicable to fire resistant as well as non-fire resistant doors). The partitions of the fire doors meet the requirements of standard **EN13501-2**.

### 2. INSTRUCTIONS

A fire-resistant door set or a non-load-bearing partition may be installed in accordance with the installation conditions specified in Table **PJ-5 APPENDIX 1** (it describes the structure types, mounting gaps, sealing material, diameter of the fastening screw and extension of the joints by section).

When installing non-fire resistant *standard* products, there are no restrictions on the wall type.

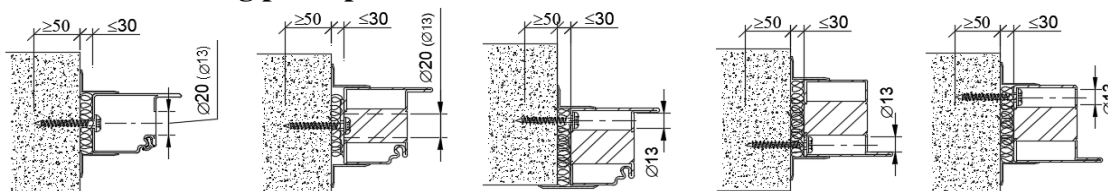
*When installing standard products with burglary class RC2-RC4, also observe PJ-5 LISA2*

The construction must be fixed tightly and firmly in the completed aperture and floor (if necessary, take into consideration the thickness of possible flooring materials when constructing the floor). The most suitable installation time is after screeding the floor and before any possible finishing work on the wall, if the side cheeks are finished without a covering strip. When using cover strips, we recommend installing the door after completing construction work, which includes painting.

#### For installation you need:

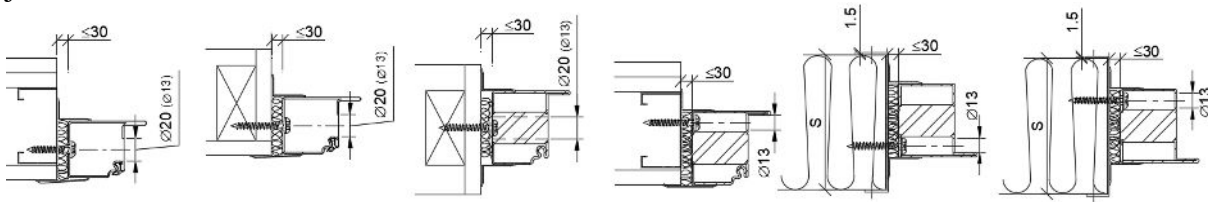
- Measuring tape, long and short spirit-levels
- Rubber hammer to install glass strips (if the glasses are not mounted on the frame)
- Electric drill and drills according to fasteners
- Torx T30 screwdriver or other according to screw type
- Tin strips to support the doorsill (if necessary)
- Lubricants for hinges and the lock
- Insulating materials (wool or assembly foam)
- Fasteners (if not ordered)
- Sealing materials if necessary (sealant etc.)

#### 2.1 Wall mounting principles:

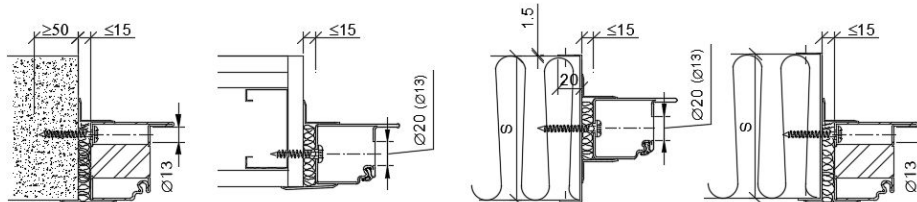


**FIGURE 1 (mounting to a rigid wall)**

When mounting the doors in lightweight blocks, make sure that the product is not installed too close to the edge of the stone. There is a great risk that the block will crack when drilling or fixing the jamb!

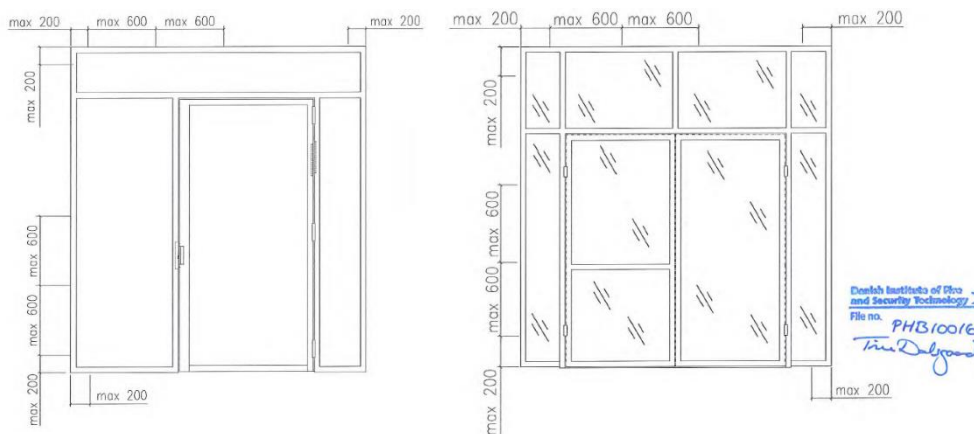


**FIGURE 2 (mounting to a non-rigid wall)**



**FIGURE 3 (smoke control doors Sa/S200)**

On the smoke control doors, the gap between the aperture and the jamb is sealed in the same way as when installing a fire-resistant door, with wool or with a Penosil fire insulation foam. Cover plates or fire-resistant silicone sealant is used for finishing.

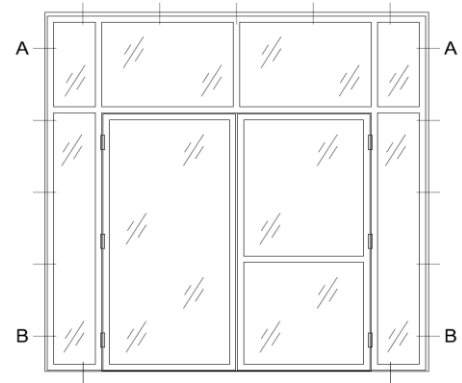


**FIGURE 4 (distance between mounting holes and locations)**

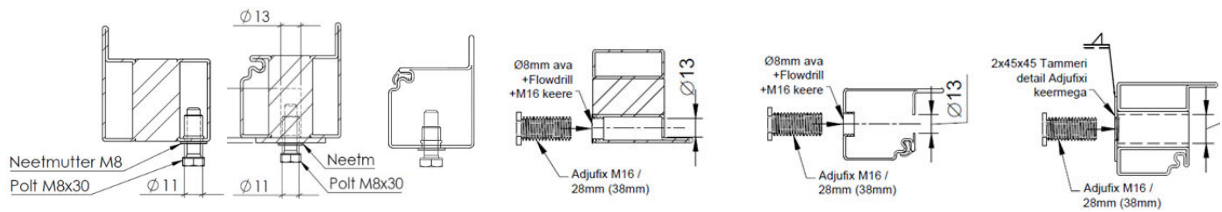
## 2.2 Installation

- When transporting the door set to the aperture, avoid damaging the surface. If necessary, cover the surfaces with cardboard, film or other materials.
- Make sure that the construction aperture and the dimensions of the door set are suitable. The gap between the construction aperture and the jamb should be the same on both sides (NB: maximum permitted mounting gap presented in **PJ-5 APPENDIX 1**. In the case of larger gaps, the construction aperture should be aligned with the required dimensions).
- Separate the door leaf/leaves from the door frame, lifting them from the hinges
- Lift the construction upright into the aperture on a finished and level floor.

- **Fix** the construction's upper corners **A** to the **vertical wall** according to the existing fixing points (see Figure 5) Do the same with the doors and windows.
- Place the door leaf (leaves) in the frame and adjust the gaps between them so that they are parallel, making sure the construction is parallel as well.
- **Fix** the construction's lower corners **B** to the **vertical wall** according to the existing fixing points (see Figure 5).
- M8x30 bolts placed in the corners can be used as an alternative fixing solution (see Figure 6).

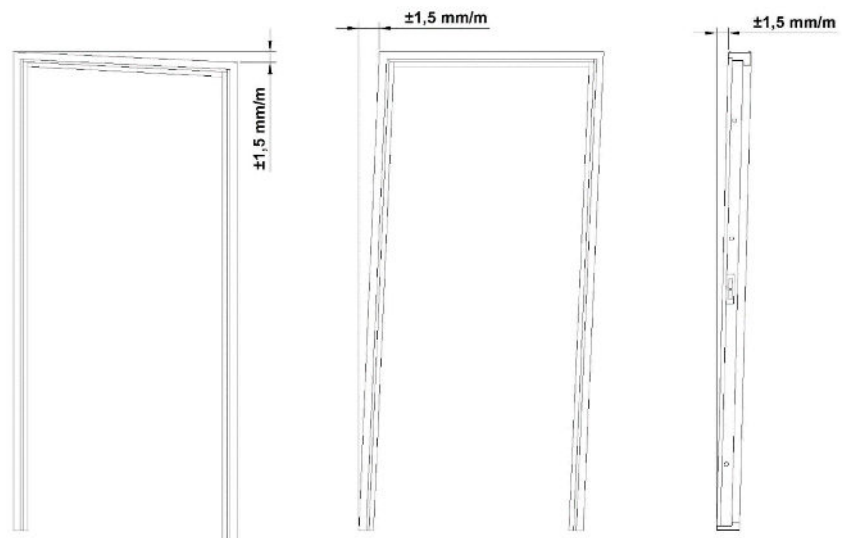


**FIGURE 5**



**FIGURE 6 (alternative fixing solution)**

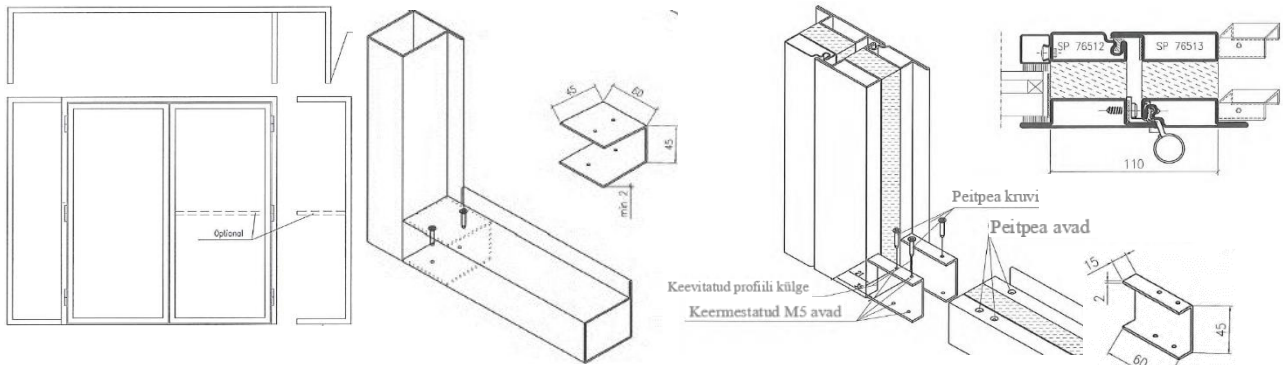
Check the door movement and gaps, make sure the frame is level and adjust, if necessary. The door / construction may, if necessary, be not level according to the frame installation tolerances accepted by the door manufacturer (see Figure 7) to ensure the door is working normally.



**FIGURE 7 (the installation tolerances of the jamb)**

- Secure the rest of the fasteners.
- In the case of weld attachments, the anchors ( $\text{Ø}$  min 7.5 mm) mounted on the wall are welded to the edge of the construction through the gap between the door and the wall.
- Fill the gap between the jamb and the wall with rock wool or assembly foam (for fire and smoke protection doors follow **PJ-5 APPENDIX1**).
- If the door is in the door set, check that it and the fittings are working properly.
- If the fittings are not installed, it must be done in accordance with the installation instructions. Make sure that the fittings meet the appropriate fire resistance class. We recommend using M-threaded screws and mounting holes not self-drilling screws to fasten the fittings to the partition profile.

- If necessary, install separately supplied glass seals and glasses (see section 2.3 Glass installation).
- Fasten the architraves with drive rivets or screws (max at 500 mm interval) on both sides of the construction and place plugs on visible mounting holes.
- The door set (door frame, top and side panels) and non-load bearing partition wall can be disassembled for transport and reassembled with a dovetail joint (see Figure 8).



**FIGURE 8 (dovetail joint)**

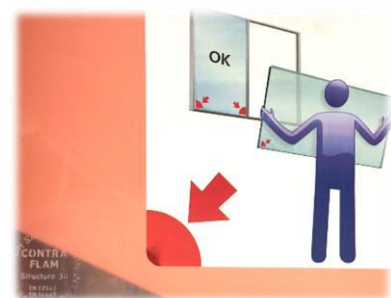
## 2.3 Installation of glasses

### 2.3.1 Installation of fire protection glasses

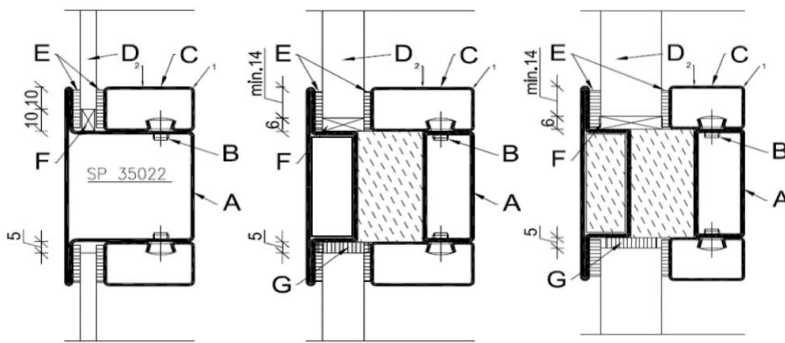
While installing the glasses (see Figure 9), make sure that they are not broken, there are no cracks or other damage. Damaged glasses may be installed only with the temporary purpose of covering an aperture, in which case the product is not in accordance with the previously stated requirements and warranty conditions.

- The glazing aperture of the frame is wiped clean from dust and dirt.
- Make sure that the glass strips (C) are installed in the same place on the construction where they were before the installation of the glasses.
- On the edge of the glass strips and the profile, a Kerafix ceramic seal of a suitable thickness is installed in the factory. If the seal is included, install it so that it's at least 1 mm lower than the exterior of the profile handle.
- If necessary, remove the fastening screws (B) from the profile (A) when placing the glass in the aperture.
  - o The glass must be installed on distance blocks, that are placed ~60-100 mm from the corners of the glass.

**NB!** When placing the **Contraflam glass** in the glazing aperture, make sure that the imprint is in the lower corner (usually the glass also has a stamp). Check that the space between edges of the glass and the profile is equal. Then insert the sealing included in the package (G) around the **perimeter of the glass edge and the frame**. No sealing is placed under the glazing blocks.



- First, install the horizontal strips of the glass (from profile to profile) and then vertical strips between them. To fasten the glass strip, hit the strip's outer corner with a rubber hammer or a wood block (**in the direction marked by arrow 1** on the figure) above the screw fastening on the base of the strip. Start fastening the strip from one end of the strip and continue towards the other end. Make sure that the strip is fastened correctly on the screws and that there is no gap between the strip and the profile. If necessary hit the strip gently above the fastening screw in the direction of the screw's axis (in the direction marked by arrow 2 on the figure).
- In an outdoor environment or in wet conditions, the surfaces of the glass seals of the fire doors must be coated with fire-resistant silicone.

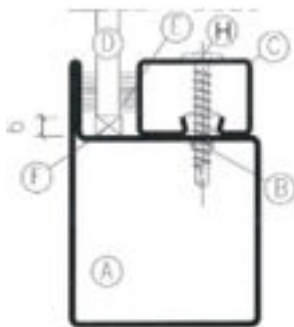


A	Profile
B	Screw of the glass seal
C	Glass strip
D	Glass
E	Kerafix seal 2-5 mm
F	Distance block
G	Kerafix seal

**FIGURE 9 (installation of glass E60 / EI30 / EI60)**

**IMPORTANT!**

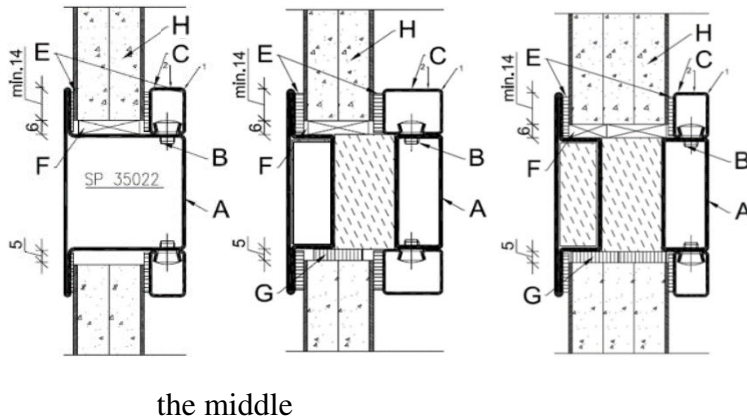
- 1) A Kerafix seal must be installed around the perimeter of **Contraflam glasses** (marked G on the figure). No seal is placed under the glazing blocks.
- 2) No seal is required in the case of 6 mm glass (Pyroswiss / FeuerFest)
- 3) In the case of **Pyroswiss 60 glass**, the strip must be fastened with extra screws (marked H on the figure), 150 mm from the edge and at max 450 mm intervals (see Figure 10)



A	Profile
B	Screw of the glass strip
C	Glass strip
D	Pyroswiss 60
E	Kerafix seal 2000 2-5 mm x 17 mm
F	Distance block
H	Self-drilling screw Ø4,8x32 mm (150 mm from the corner of the glass strip and at max 450 mm intervals)

**FIGURE 9 (Installation of Pyroswiss E60 6 mm glass)**

- Instead of glass, there may be a casing that is similar to the installation of the glass (see Figure 11).

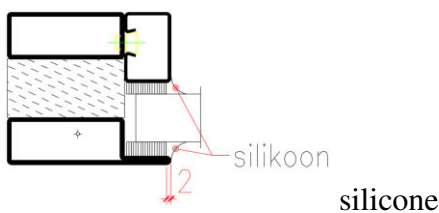


- E30-EW60, EI30 casing composition: 1,5 mm steel leaf on both sides, 2 gypsum boards in the middle, no additional seal (G) necessary to install on E30-EW60 casing
- Composition of EI60 casing: 1,5 mm steel leaf on both sides, 3 gypsum board in

**FIGURE 10 (installation of casing E60 / EI30 / EI60)**

### 2.3.2 Installing glasses and casing on non-fire-resistant doors

- Make sure that a glass seal of appropriate thickness is installed on the glass strips and the profile's edge.
- The seals are included with the products and the manufacturer T-Tammer OÜ ensures that the seal can be used both in indoor and outdoor conditions.
- The glass must be installed on distance blocks that are placed ~100 mm from the corners of the glass.
- After placing the glass on the distance blocks, you can insert silicone between the edge of the glass and the frame, or install seal strips to fix the location of the glass (make sure that the space between the profile and glass is equal on both sides)
- We recommend fastening the seal with silicone when the seal is used in outdoor conditions, as there is a danger of water flow between the glass and frame due to complicated weather conditions. In order to do that, a square EPDM sponge seal has to be used, which is placed approximately 2 mm lower than the outer surface of the profile and is covered with silicone.



- When installing non-fire-resistant barriers between sheets of steel, a Styrofoam board or the like may be installed, otherwise follow the glazing instructions in section 2.3.2.